

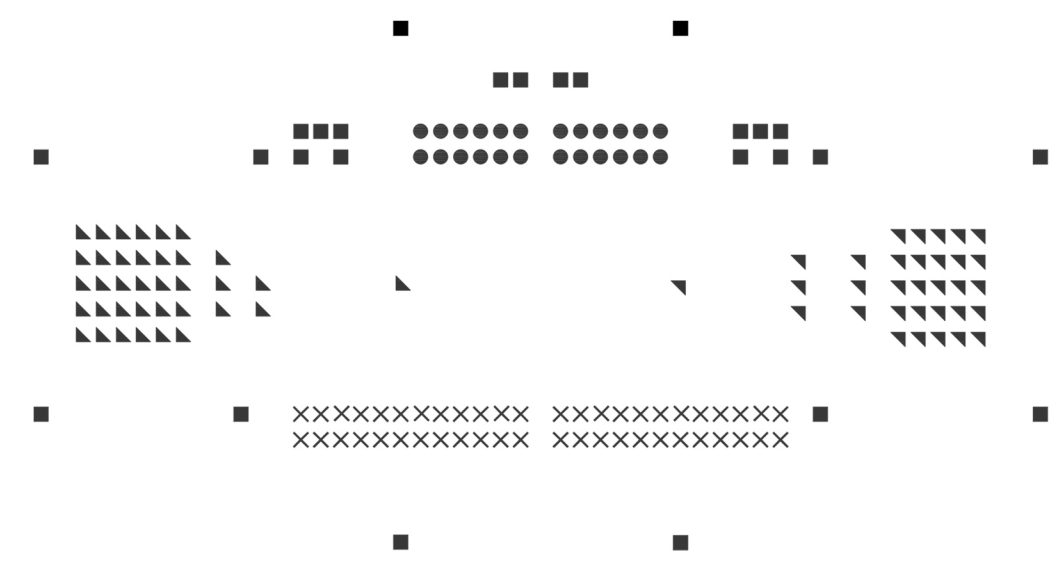

# Nature Justice Wandering Tribunal of Waters

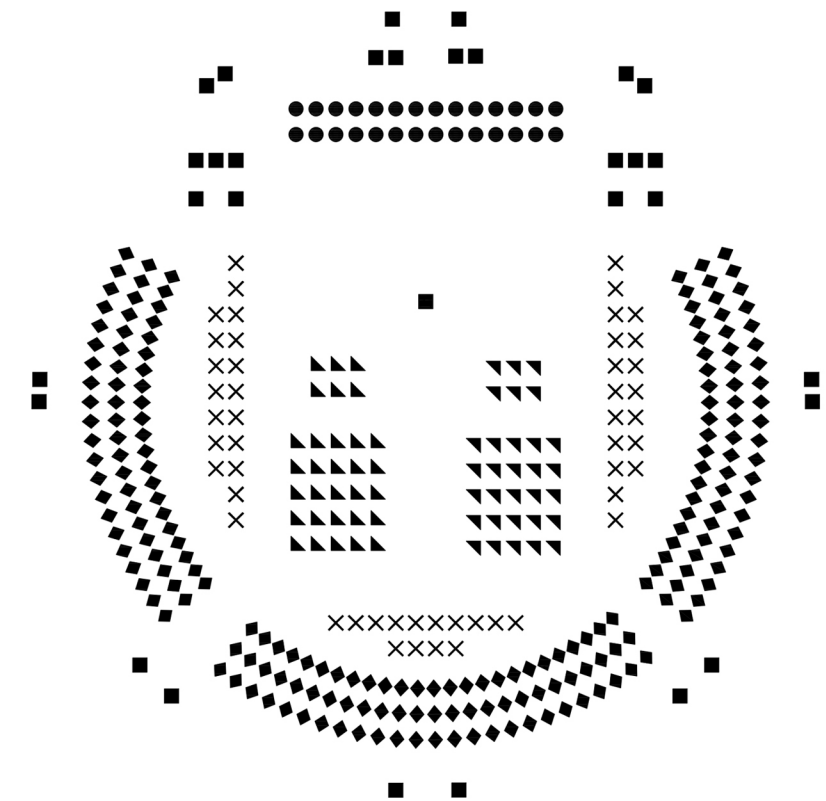
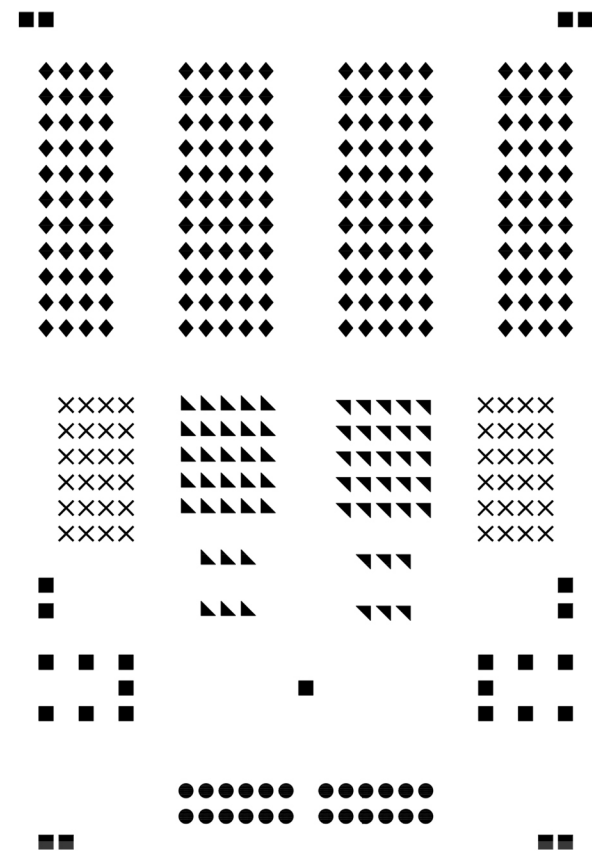

Country / City ..... Greece, Patras  
 University / School ..... University of Patras, School of Engineering, Department of Architecture  
 Academic year ..... 2019-2020  
 Title of the project ..... Nature Justice: Wandering Tribunal of Waters  
 Authors ..... Anna Biza, Konstantina - Anna Sofianidi

## TECHNICAL DOSSIER

Title of the project ..... Nature Justice: Wandering Tribunal of Waters.....  
Authors ..... Anna Biza, Konstantina-Anna Sofianidi.....  
Title of the course ..... Diploma and grade.....  
Academic year ..... 2019-2020.....  
Teaching Staff ..... Professor Demetra Katsota.....  
Department/Section/Program of belonging ..... Department of Architecture.....  
University/School ..... University of Patras, School of Engineering.....



Written statement, short description of the project in English, no more than 250 words

.....  
The mythological Acheloos, the ancestor of all rivers, fought with Hercules, symbolizing the timeless toil of man to turn destructive river power into a creative one. Today, the Acheloos River is a network of natural and artificial ecosystems, whose boundaries are either intensifying or disappearing. In 2031, with the Universal Declaration of the Rights of the Water Bodies, these natural elements acquire legal personhood. The two conflicting sides are now the Greek State and the newly formed Company of Acheloos. The Wandering Tribunal of Waters becomes responsible for resolving their disputes. It traces the water body and locates four landscapes-witnesses to it: the dam, the yard, the isle and the ruin. According to their seasonality and physical / artificial organization, an outdoor court hearing is planned for each. There, the case of Acheloos unfolds and is judged as the landscapes testify and deposit a piece of the history of the dual nature of the river.  
.....

For further information  
**Máster d'Arquitectura del Paisatge -DUOT - UPC**

T: + 34 93 401 64 11 / +34 93 552 0842  
Contact via email at: [biennal.paisatge@upc.edu](mailto:biennal.paisatge@upc.edu)

**Máster d'Arquitectura del Paisatge -DUOT - UPC**  
ETSAB- Escola Tècnica Superior  
d'Arquitectura de Barcelona  
Avenida Diagonal, 649 piso 5  
08028 Barcelona-Spain



# CLIMATE CHANGE AGAIN

11th International Biennial Landscape Barcelona

Barcelona September 2020  
SCHOOL PRIZE



# Nature Justice

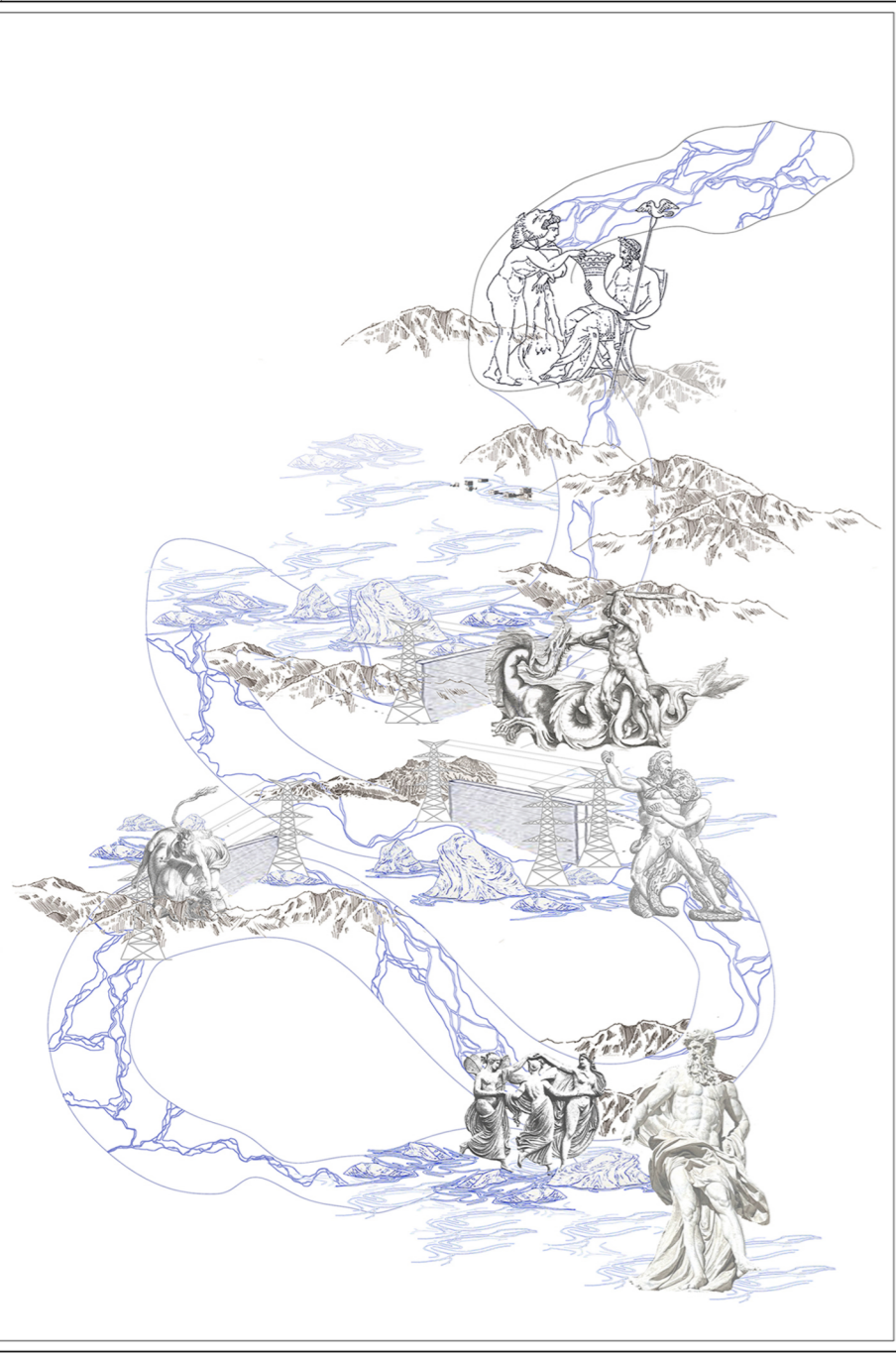
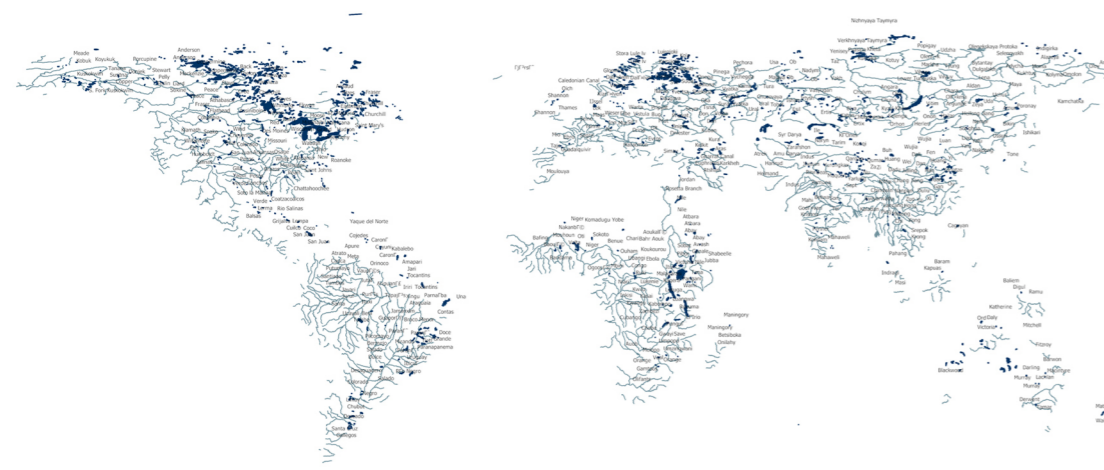

# CONVENTION ON THE RIGHTS OF WATER BODIES

**CHAPTER I**  
**OBJECT AND PRINCIPLES**

**Article 1.** This Act is intended to recognize the rights of Water Bodies, and the obligations and duties of the States Parties and society to ensure respect for these rights.

**Article 2.** The binding principles that govern this law are:

1. Harmony. Human activities, within the framework of plurality and diversity, should achieve a dynamic balance with the cycles and processes inherent in Water Bodies.
2. Collective good. The interests of societies, within the framework of the rights of Water Bodies, prevail in all human activities and any acquired right.
3. Guarantee of the regeneration of Water Bodies. The States Parties, at its various levels, and society, in harmony with the common interest, must ensure the necessary conditions in order that the diverse living systems of Water Bodies may absorb damage, adapt to shocks, and regenerate without significantly altering their structural and functional characteristics, recognizing that living systems are limited in their ability to regenerate, and that humans are limited in their ability to undo their actions.
4. Respect and defend the rights of Water Bodies. The States Parties and any individual or collective person must respect, protect and guarantee the rights of Water Bodies for the well-being of current and future generations.
5. No commercialism. Neither living systems nor processes that sustain them may be commercialized, nor serve anyone's private property.
6. Multiculturalism. The exercise of the rights of Water Bodies requires the recognition, recovery, respect, protection, and dialogue of the diversity of feelings, values, knowledge, practices, skills, transference, transformation, science, technology and standards, of all the cultures of the world who seek to live in harmony with nature.

**CHAPTER II**  
**WATER BODIES. DEFINITION AND CHARACTER**

**Article 3.** Water Bodies are dynamic living systems comprising an indivisible community of all living systems and living organisms, interrelated, interdependent and complementary, which share a common destiny.

**Article 4.** Living systems are complex and dynamic communities of plants, animals, microorganisms and other beings and their environment, where human communities and the rest of nature interact as a functional unit under the influence of climatic, physiographic, and geological factors, as well as production practices, cultural diversity, and the worldviews of nations.

**CHAPTER III**  
**RIGHTS OF WATER BODIES**

**Article 7.** Water Bodies have the following rights:

1. To life. The right to maintain the integrity of living systems and natural processes that sustain them, and capacities and conditions for regeneration.
2. To the diversity of life. It is the right to preservation of differentiation and variety of being that make up Water Bodies, without being genetically altered or structurally modified in an artificial way, so that their existence, functioning or future potential would be threatened.
3. To water. The right to preserve the functionality of the water cycle, its existence in the quantity and quality needed to sustain living systems, and its protection from pollution for the reproduction of the life of the Water Bodies and all its components.
4. To clean air. The right to preserve the quality and composition of air for sustaining living systems and its protection from pollution, for the reproduction of the life of Water Bodies and all its components.
5. To equilibrium. The right to maintenance or restoration of the interrelationship, interdependency, complementary and functionality of the components of Water Bodies in a balanced way for the continuation of their cycles and reproduction of their vital processes.
6. To restoration. The right to timely and effective restoration of living systems affected by human activities directly or indirectly.
7. To pollution-free living. The right to the preservation of any of Water Bodies' components from contamination, as well as toxic and radioactive waste generated by human activities.

**CHAPTER IV**  
**STATE OBLIGATIONS AND SOCIETAL DUTIES**

**Article 8.** The States Parties, at all levels and geographical areas and across all authorities and institutions, has the following duties:

1. Uphold and respect the rights of Water Bodies.
2. Promote harmony with Water Bodies in all areas of its relationship with other human communities and the rest of nature in living systems.
3. Participate actively, individually or collectively, in generating proposals designed to respect and defend the rights of Water Bodies.
4. Assume production practices and consumer behavior in harmony with the rights of Water Bodies.
5. Ensure the sustainable use of Water Bodies' components.
6. Report any act that violates the rights of Water Bodies, living systems, and/or their components.
7. Attend the convention of competent authorities or organized civil society to implement measures aimed at preserving and/or protecting Water Bodies.

**Article 10.** Establishing the Wandering Tribunal of Waters, whose mission is to ensure the validity, promotion, distribution and compliance of the rights of Water Bodies established in this Act. A special law will establish its structure, function, and attributes.

21 January 2031 UNITED NATIONS

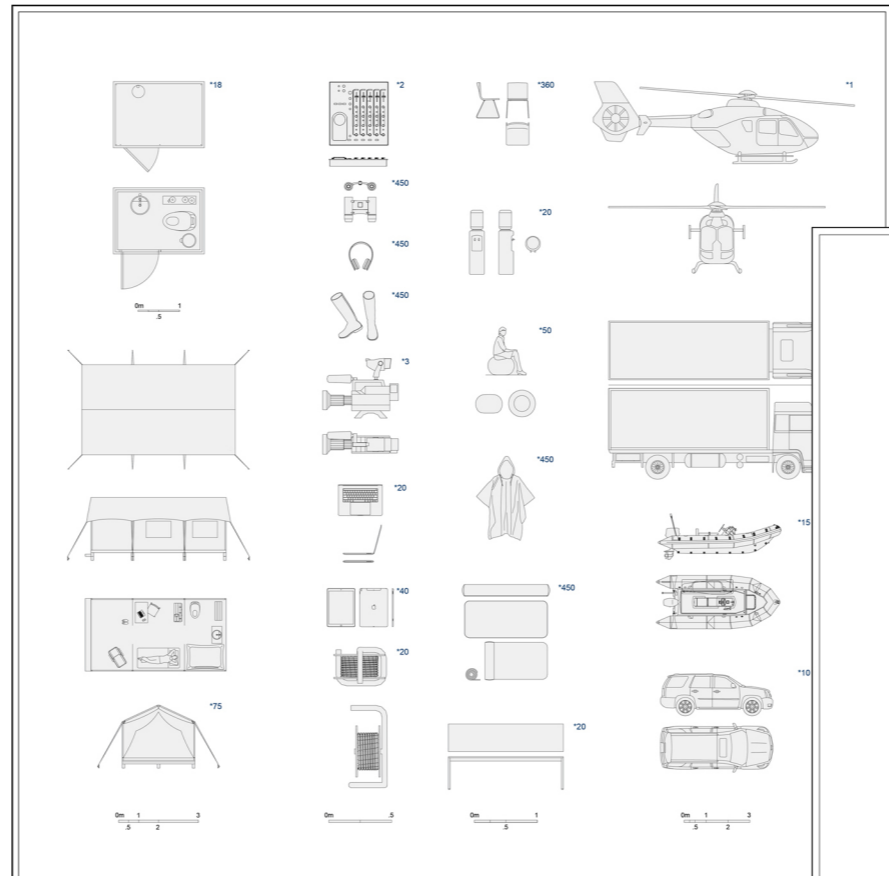

# Parts

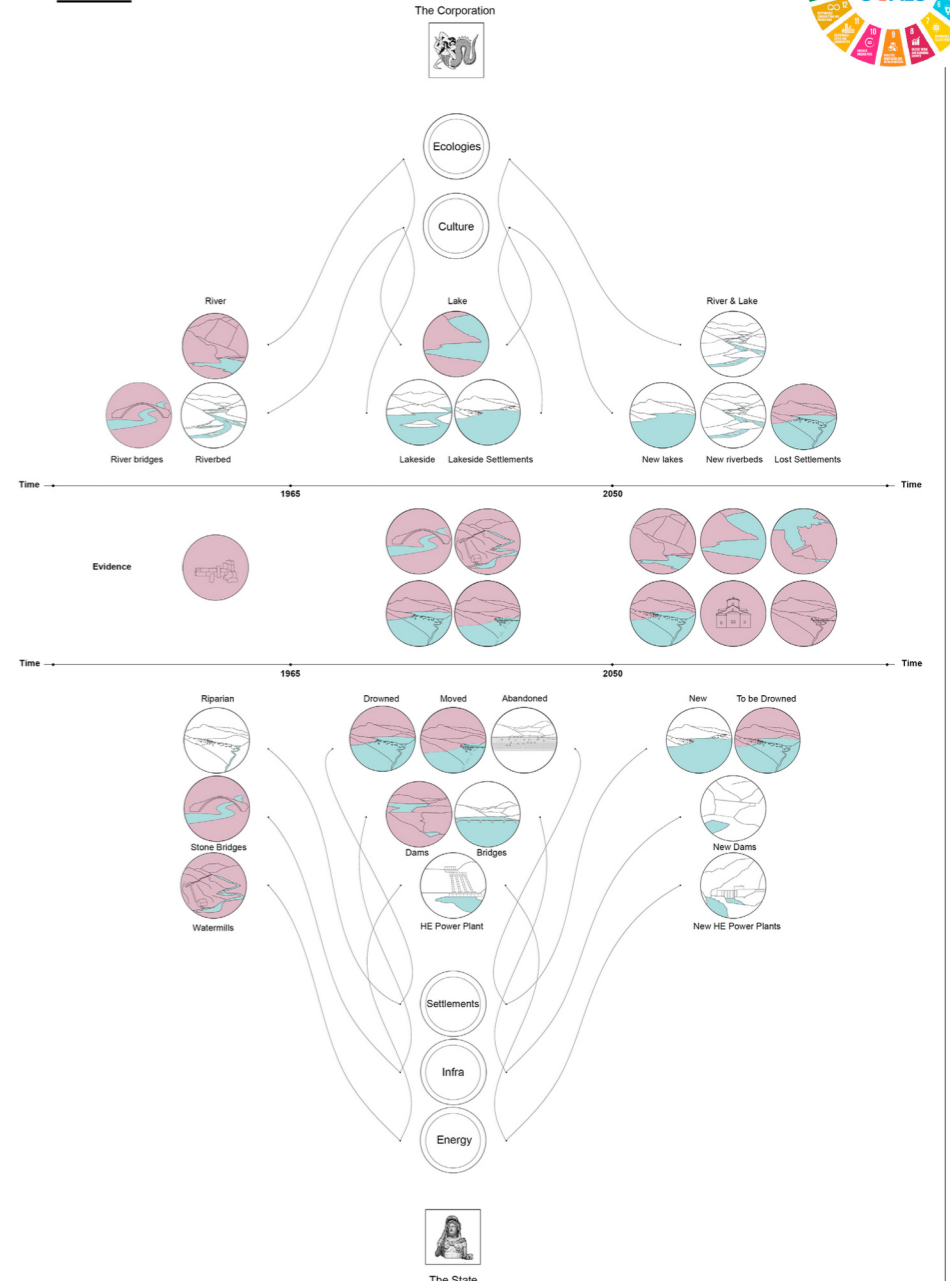

# The Tribunal

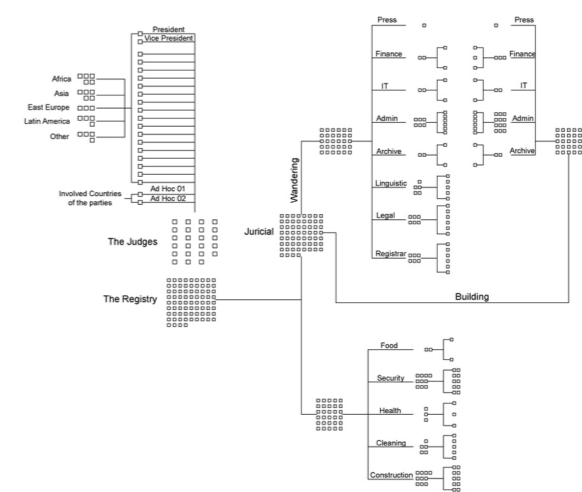

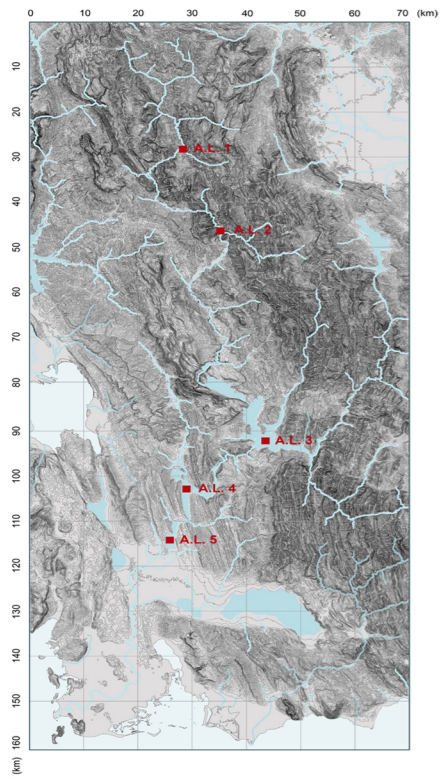

**The Artificial Lakes**

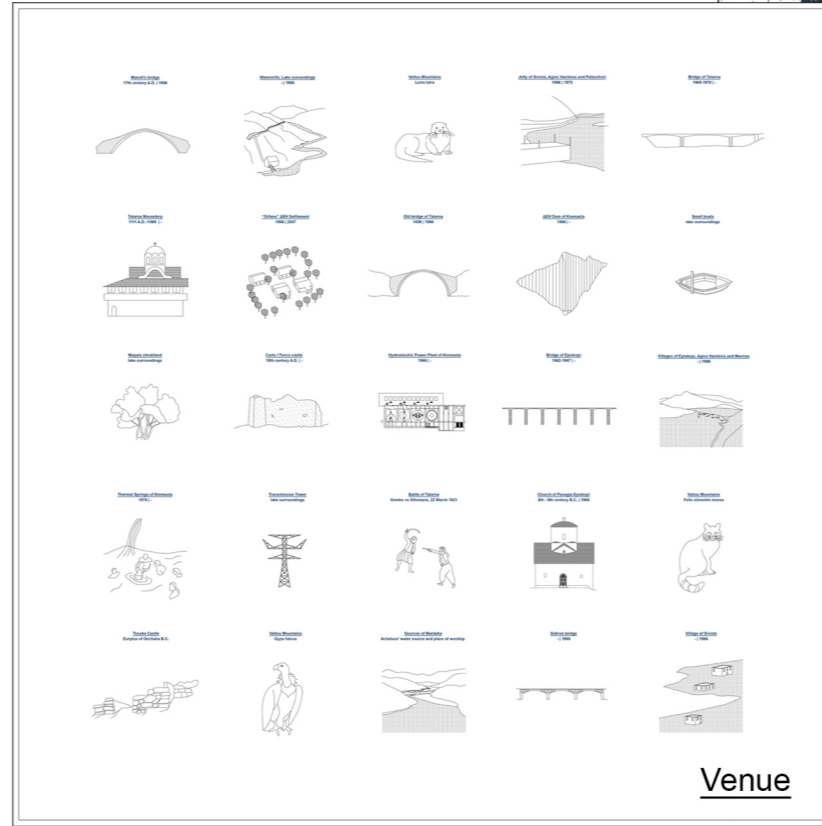
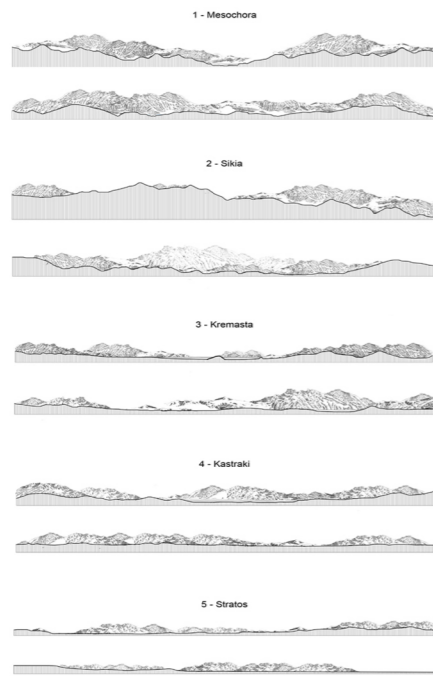

**Venue**

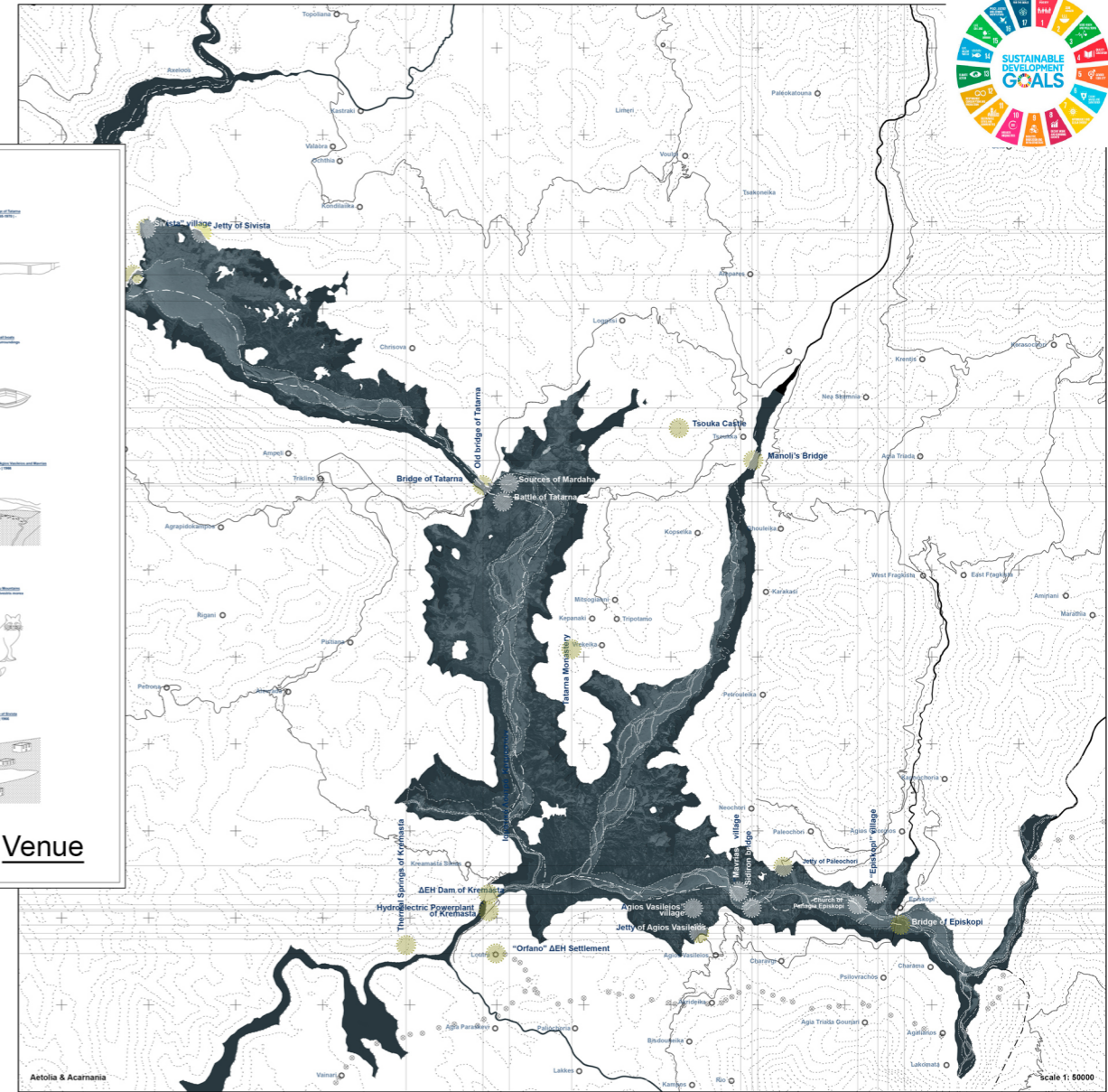

**Body of Evidence**

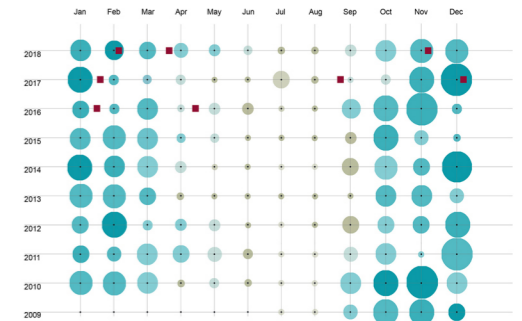
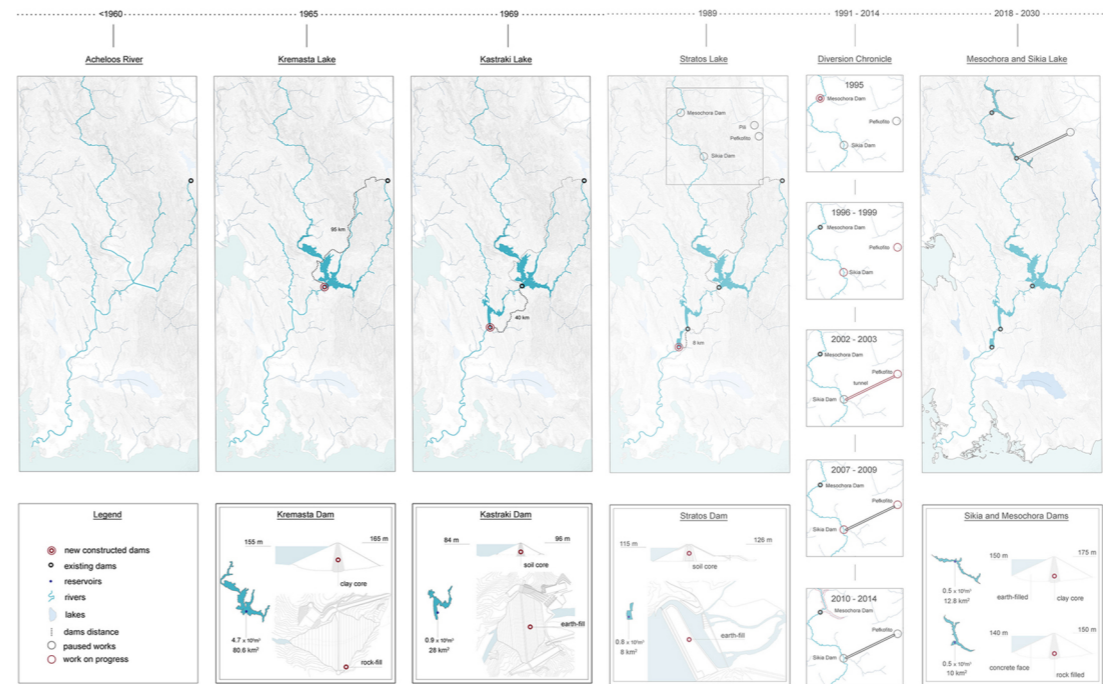
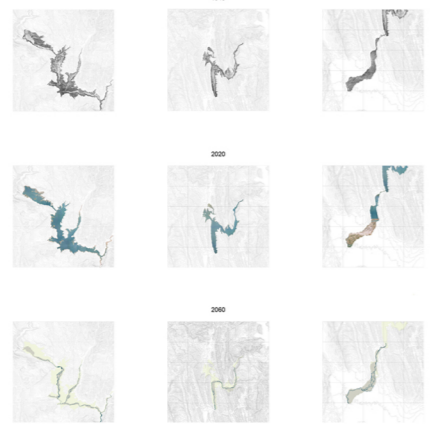
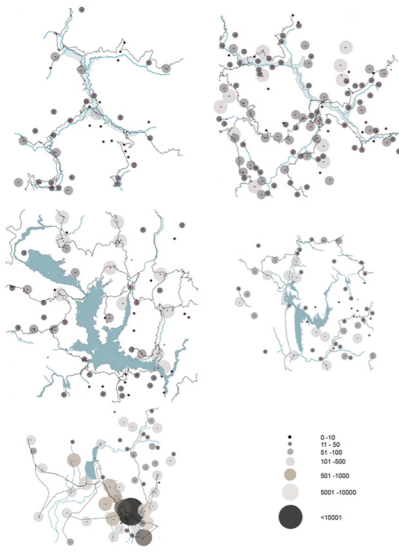
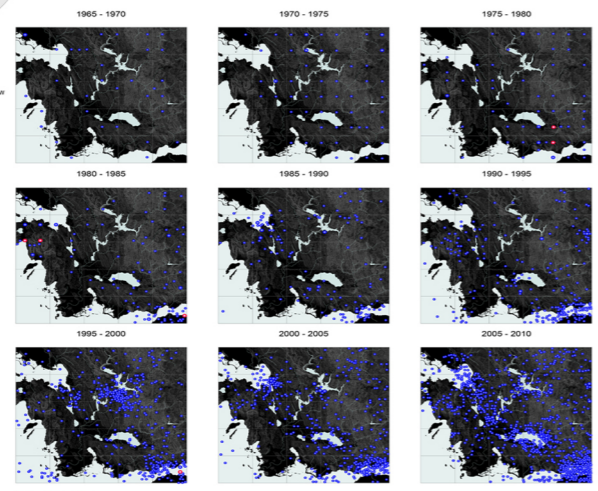
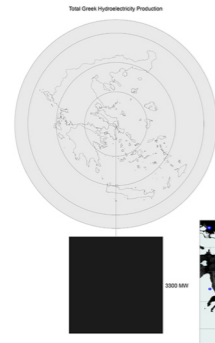
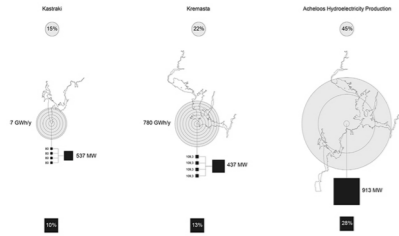

**Legal Dispute**



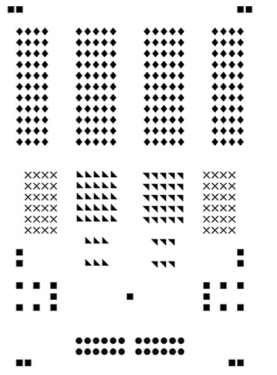
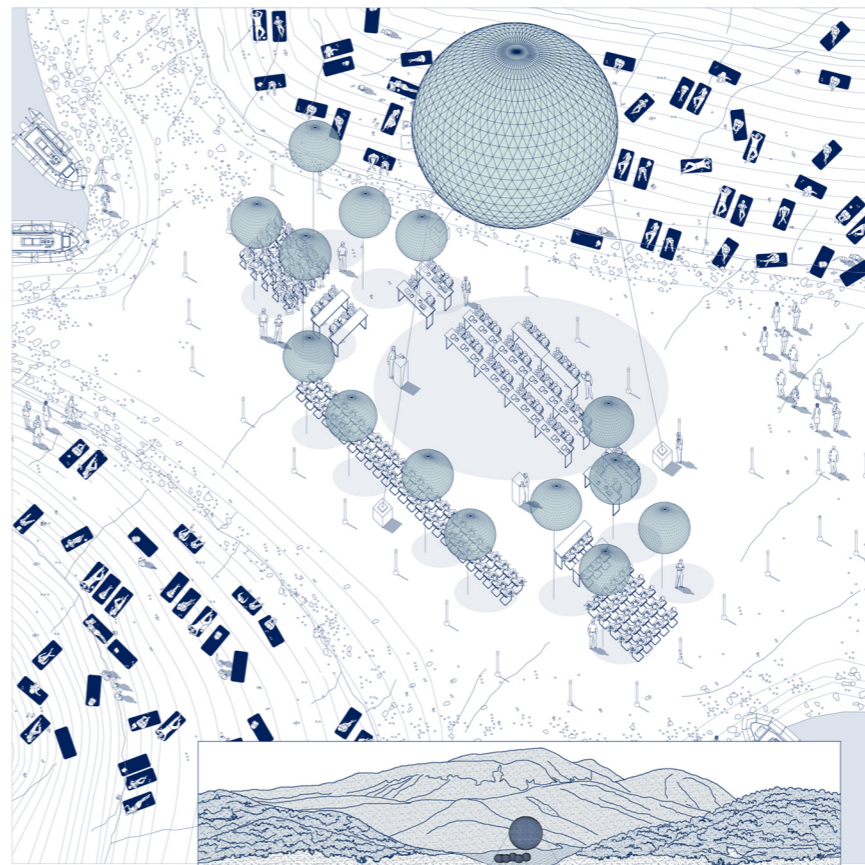
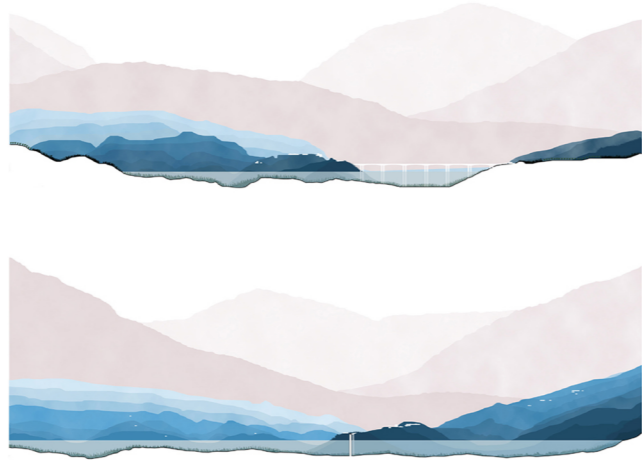
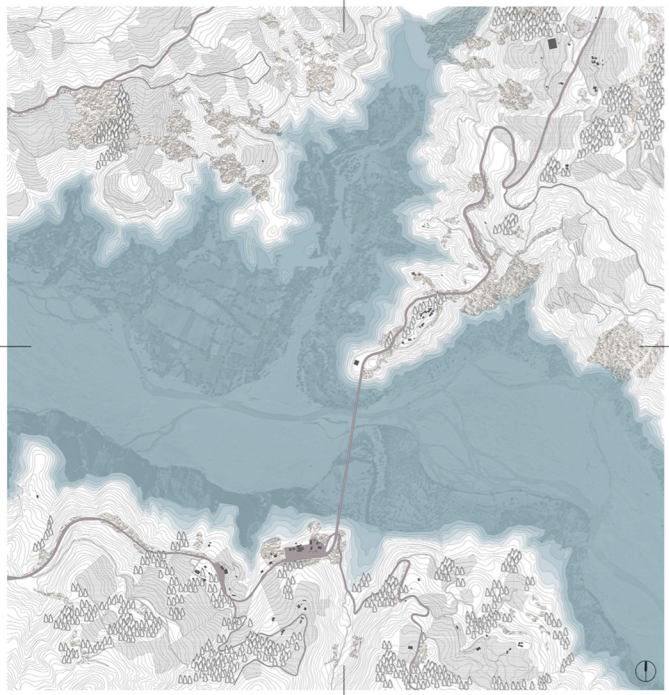

■ registry ● judge × press ↘ part 01 ↙ part 02

Judge of Res. Judge. Planner. Register. Agent. Agent. Advisor. Advisor. Counsel. Witness.

